

PERFORMANCE INSURANCE

PRODUCTION TOOLS • SHOW CONTROL • BACKUP SOLUTIONS

OSCA-18

8-Way OSC Programmable General Purpose Input

USER GUIDE

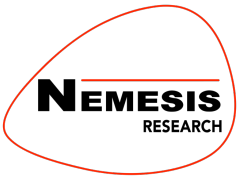

PERFORMANCE INSURANCE

PRODUCTION TOOLS • SHOW CONTROL • BACKUP SOLUTIONS

Overview

The OSCA-I8 is a next generation multiple command destination show control solution featuring OSC Network input, POE IEEE 802.3 or 5v DC powering and eight isolated inputs.

Front Panel



Rear Panel Connections

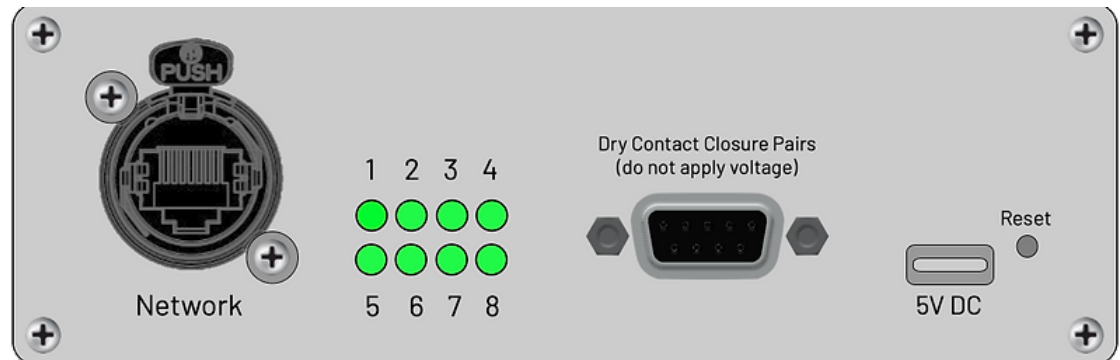

Power & Network – OSCA can be powered by POE IEEE 802.3 or 5v DC via the USB C port

4 Display LED's – LED will illuminated to indicate input activated

GPI DSUB – 8 opto-isolated inputs and common ground. Can be activated by contact closure or open collector output

Network Settings

Default IP settings

IP Address	192.168.1.253
Subnet Mask	255.255.255.0
Gateway	192.168.1.1
DNS Main	192.168.1.1
DNS Backup	192.168.1.1
Network Device Name	OSCA-I8

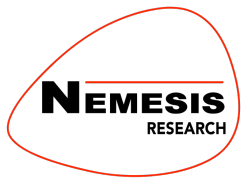

PERFORMANCE INSURANCE

PRODUCTION TOOLS • SHOW CONTROL • BACKUP SOLUTIONS

OSC Listen Port	53500
-----------------	-------

In order to change settings navigate to the device's IP address (default: 192.168.1.253) on the network using a web browser or use its network name (default: OSCA-l8) and navigate to the "Network page"

In order for changes to take effect press save and then restart (Please note if you have changed IP address or device name the page may not refresh, and you will need to open a new tab in your browser with the new user settings).

Destination Settings

On the Destinations page, you can specify and name destinations (a maximum of 8 when in advanced mode and 2 when in a preset) which will be stored in the device's memory. Please specify the IP address and OSC listen to port of the receiving device(s).

Input Settings

Each input can send up to two messages (Command), with each one sent to one of eight destinations. (to send the same command to both destinations send identical command to each location)

The device comes with three pre-sets built-in with predefined commands for CSC and Qlab and OSCA-04.

All commands in these pre-sets will be sent to Destination 1 and 2 (if specified on the destinations page)

Qlab Preset

Button	Function	Command
1	Go	/go
2	Stop	/panic
3	Previous	/playhead/previous
4	Next	/playhead/next
5	Not used	

When using this pre-set it may be necessary to configure QLab to allow OSC connection access without a passcode.

CSC Preset

Button	Function	Message (Command)
1	Go	/cuelist/go
2	Stop	/cuelist/stop
3	Previous	/cuelist/prev
4	Next	/cuelist/next
5	Not used	

OSCA-04 Preset

Button	Function	Address	Integer Argument
1	Relay 1 ON	/relay/1	1
2	Relay 2 ON	/relay/2	1
3	Relay 3 ON	/relay/3	1

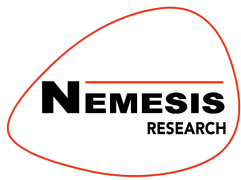

PERFORMANCE INSURANCE

PRODUCTION TOOLS • SHOW CONTROL • BACKUP SOLUTIONS

4	Relay 4 ON	/relay/4	1
5	All relays OFF	/relay/?	0

Advanced Mode – Inputs

By putting the device into advanced mode and navigating to the inputs menu the user can specify custom messages (Commands) for each of your inputs. The OSCA can send up to two arguments with each command. OSCA will automatically determine the format of the argument based on the value. For example, 1 will be sent as an integer, 1.00 as a float and one as a string. OSCA will also automatically read the entered OSC command (String) and determine what is the address and argument(s). For further information please see www.nemesis-research.com/opensoundcontrol

A debounce time can be set per button in milliseconds. This is the time after the button is released before it can be pressed again. (the default is set to 250ms)

OSCA has a maximum length for the command which is 192 characters.

You can then select which destination you would like this command to be sent to. Each input can send up to two commands, with each command being sent to one destination. (To send the same Command to 2 destinations send identical commands to each receiving device)

Firmware Update

If connected to the internet you can use the Firmware update page to install the latest firmware from the Nemesis server.

Additional Information

Incoming OSC

OSCA will react to incoming OSC messages on the port specified.

e.g., /input/1 Will send the commands specified by input 1 as if input 1 had been activated.

Power

OSCA can be powered by POE or 5v DC via the USB C port

Factory Reset

Press the reset button at power on to reset the network settings to default. Please then power cycle the unit for the changes to take effect.

Pin Outs

GPI: 9 Pin Female D-Sub. Closed contact to GND, opto-isolated input.

Option	Function
1	Input 1
2	Input 2
3	Input 3
4	Input 4
5	Input 5
6	Input 6
7	Input 7
8	Input 8

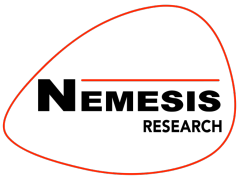

PERFORMANCE INSURANCE

PRODUCTION TOOLS • SHOW CONTROL • BACKUP SOLUTIONS

9	GND
---	-----

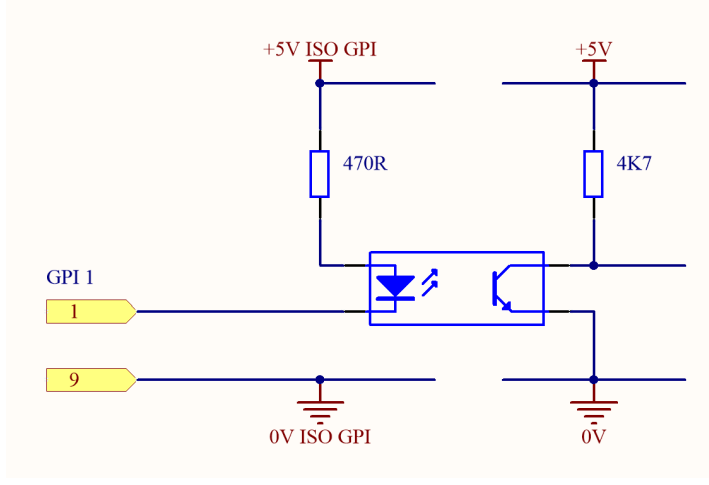

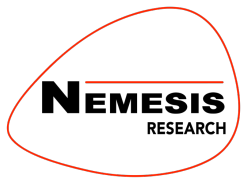

PERFORMANCE INSURANCE

PRODUCTION TOOLS • SHOW CONTROL • BACKUP SOLUTIONS

EU declaration of conformity (CE symbol)

This declaration applies to
- OSCA-I8 XX:XX:XX:XX:XX:XX
manufactured by Nemesis Audio



All products of type OSCA-I8 are included, provided they correspond to the original technical version and have not been subject to any later design or electromechanical modifications.

We herewith declare that said products are in conformity with the provisions of the respective EC directives including all applicable amendments.

A detailed declaration is available on request and can be ordered from Nemesis Audio.

WEEE Declaration (Disposal)

Electrical and electronic equipment must be disposed of separately from normal waste at the end of its operational lifetime.

Please dispose of this product according to the respective national regulations or contractual agreements. If there are any further questions concerning the disposal of this product please contact Nemesis Audio.

Nemesis Audio
c/o Orbital Sound Ltd
57 Acre Lane
London
SW2 5TN
United Kingdom

information@nemesis-audio.com

- END OF DOCUMENT -